

Order picking truck 1.8 -2.0 ton

BT optio

L-series

OSE200X

OSE180XP



Order picking truck

Truck specifications					OSE200X	OSE180XP
Identification	1.1	Manufacturer			Toyota	Toyota
	1.2	Model			OSE200X	OSE180XP
	1.3	Drive			Electric	Electric
	1.4	Operator type			Stand on	Stand on
	1.5	Load capacity/rated load	Q	kg	2000/1800 ³⁾	1800
	1.6	Load centre	c	mm	1200/1400	1200/1400
	1.8	Load distance, back of fork to bogie wheel centre	x	mm	1485	1485
	1.9	Wheelbase, short/long chassis	y	mm	2690/2776	2690/2776
	Weight	2.1	Service weight without battery, short/long chassis		kg	1201/1225
2.2		Axle load, with load, drive/castor/fork wheels short chassis long chassis		kg	780/836/943	780/836/943
				kg	680/673/1144	680/673/1144
2.3		Axle load, without load, drive/castor/fork wheels short chassis long chassis		kg	597/500/339	597/500/339
				kg	746/570/293	746/570/293
Wheels		3.1	Drive/castor/fork wheels			Polyurethane
	3.2	Wheel size, front		mm	Ø 250 x 92	Ø 250 x 92
	3.3	Wheel size, rear		mm	Ø 85 x 74	Ø 85 x 74
	3.4	Additional wheels (dimensions)		mm	Ø 150 x 78	Ø 150 x 78
	3.5	Wheels, number front/rear (x=driven wheels)		mm	1x+ 1/4	1x+ 1/4
Dimensions	4.2.1	Overall height	h_{15}	mm	1370	2199
	4.4	Lift Lift height	h_3	mm	710	710
			h_{23}	mm	800	800
	4.8	Stand height, min./max.	h_7	mm	138	138/980
	4.15	Height, fork lowered	h_{13}	mm	90	90
	4.19	Overall length, short/long chassis	l_1	mm	3784/3870	3784/3870
	4.20	Length to face of forks, short/long chassis	l_2	mm	1434/1520	1434/1520
	4.21	Overall width	b_1	mm	790	790
	4.22	Fork dimensions	s/e/l	mm	70/180/2350, 2850 ³⁾	70/180/2350, 2850
	4.25	Width over forks	b_5	mm	550-570	550-570
	4.31	Ground clearance	m_1	mm	23	23
	4.34	Aisle width for pallets 800 x 1200 lengthways	A_{st}	mm	3819	3819
	4.35	Turning radius, short/long chassis	W_a	mm	2704/2790	2704/2790
	4.44	Clear width driver compartment entrance	l_{24}	mm	450	450
Performance data	5.1	Travel speed, with/without load ¹⁾		km/h	8,5/12,0	7,0/12,0
	5.2	Lift speed, with/without load		m/s	0,07/0,12	0,07/0,12
	5.3	Lowering speed, with/without load		m/s	0,12/0,12	0,12/0,12
	5.8	Max. gradeability, with/without load ¹⁾		%	5/5	5/5
	5.10	Service brake			Electromagnetic	Electromagnetic
Electric motor	6.1	Drive motor rating S2 60 min		kW	2,8	2,8
	6.2	Lift motor rating S3 7%		kW	2,0	2,0
	6.4	Battery voltage, nominal capacity K_5		V/Ah	24/620	24/620
	6.5	Battery weight, min./max.		kg	239-501	239-501
	6.6	Energy consumption acc to VDI cycle ²⁾		kWh/h	60	60
	Other	8.1	Type of drive control			BT Powerdrive
8.4		Sound level at the driver's ear according to EN 12 053		dB(A)		

1) Measured according to company standard.

2) Contact your supplier for information.

3) Fork length 2850 mm @ LC 1400 mm gives 1800 kg capacity.

*) Values are for 620Ah battery. Other batteries will give other values.

All data are based on table configuration. Other configurations may give other values.

Truck performance and dimensions are nominal and subject to tolerances.

Toyota Material Handling Manufacturing Sweden AB products and specifications are subject to change without notice.

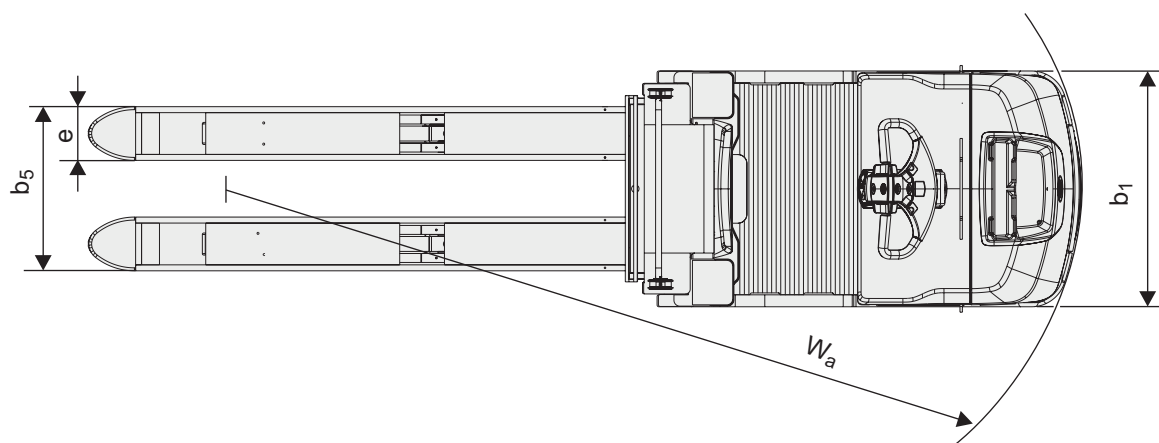
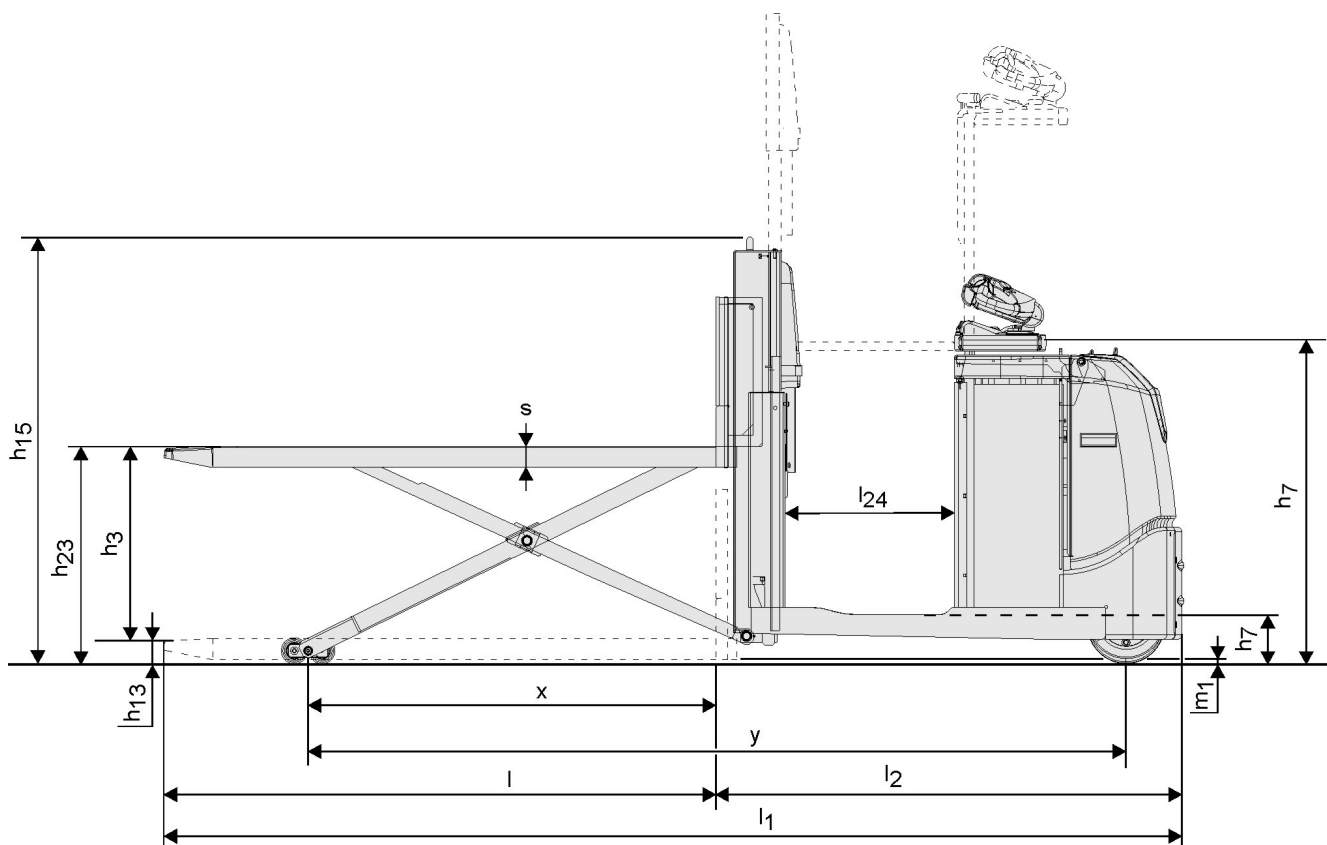

Truck features:

- High performance models
- High capacity, high lifting forks
- BT E-man steering concept
- Low step-in
- BT Powerdrive system
- Sensi-platform lift
 - including elevating controls (P-model)
- Integrated shrink film holder
- Streamlined administration
 - E-bar concept (option)
- Frequency adapted suspension (option)



TMHE-Toyota Material Handling Europe — 746575-040, version 8, 2019-08-01

TOYOTA

MATERIAL HANDLING